









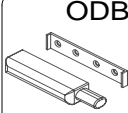
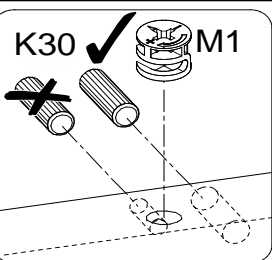
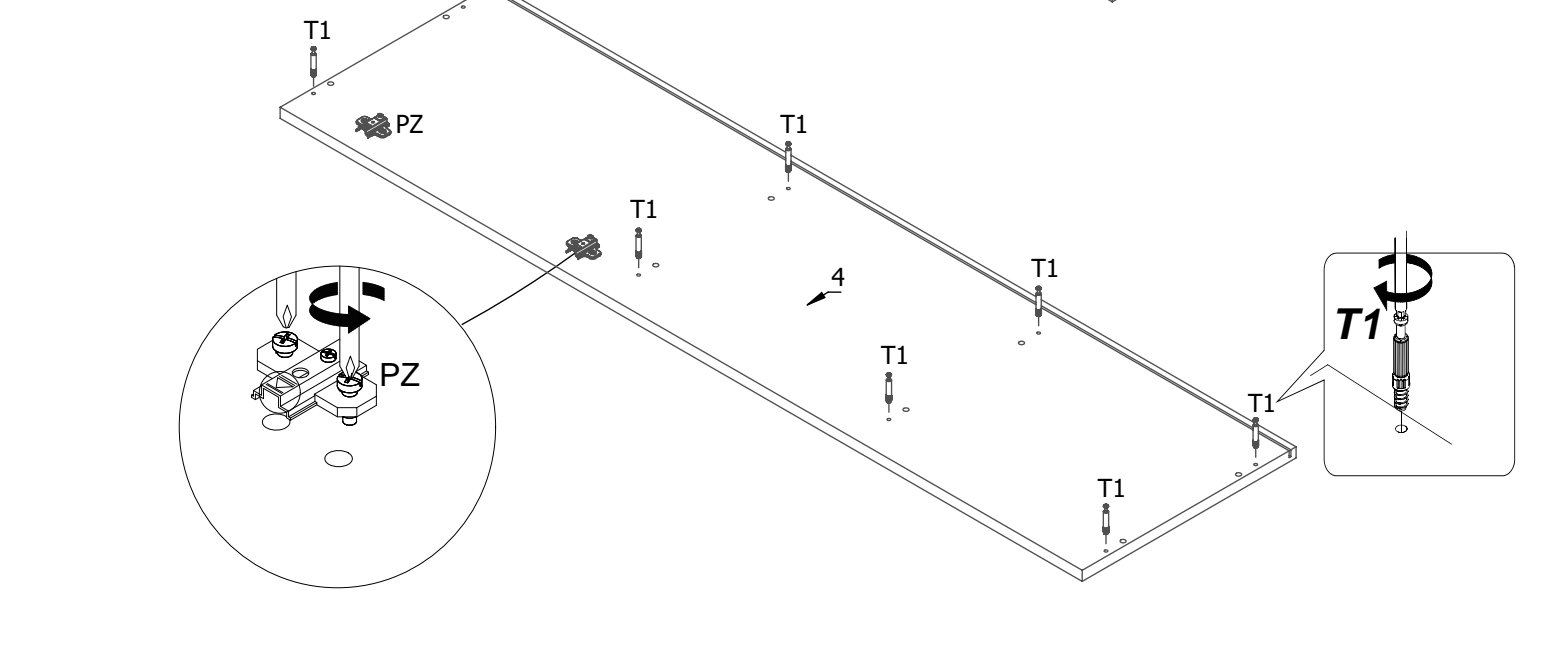
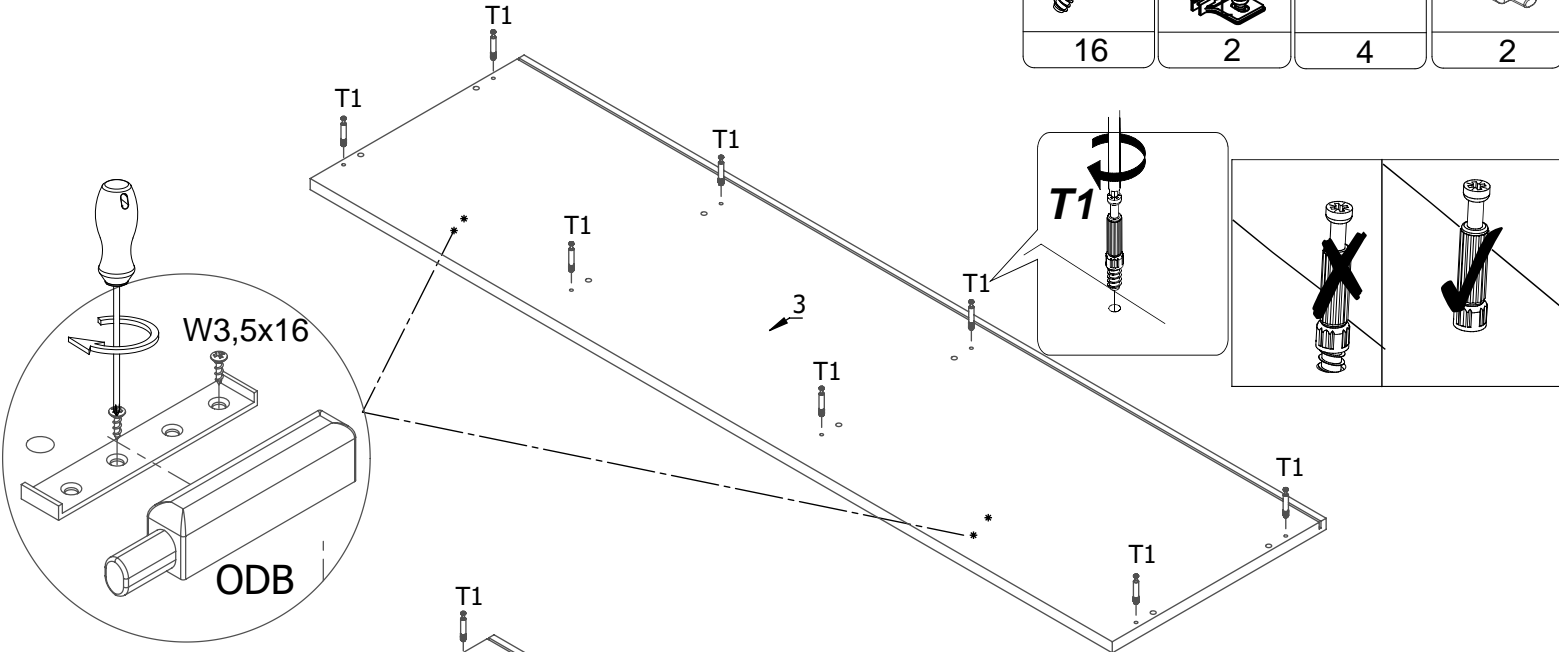

<p>K30</p> <p>16</p>	<p>T1</p> <p>16</p>	<p>M1</p> <p>16</p>	<p>ZP</p> <p>4</p>	<p>PZ</p> <p>4</p>	<p>F2</p> <p>15</p>	<p>S2</p> <p>1</p>	<p>S3</p> <p>1</p>
<p>STB</p> <p>8</p>	<p>PS</p> <p>4</p>	<p>W4x16</p> <p>8</p>	<p>Z1</p> <p>16</p>	<p>H120</p> <p>5</p>	<p>ODB</p> <p>2</p>	<p>S1</p> <p>1</p>	<p>W3,5x16</p> <p>4</p>

T1 	PZ 	W3,5x16 	ODB 
16	2	4	2

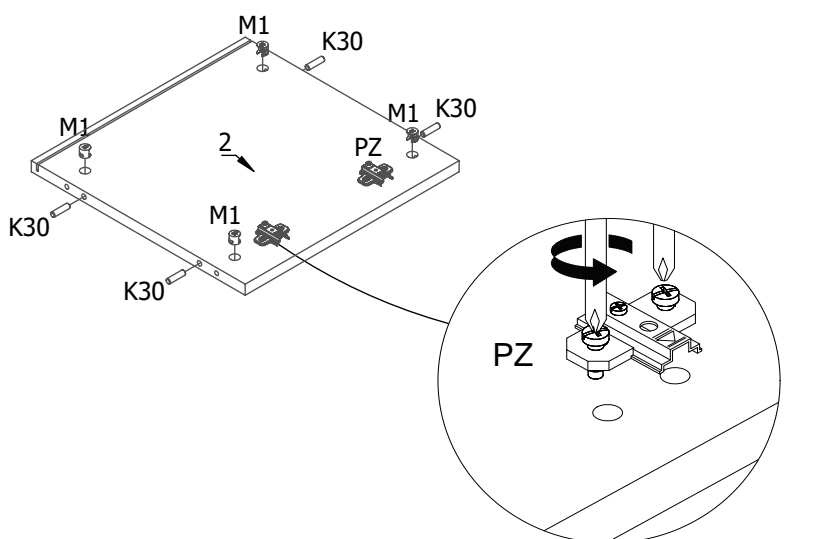
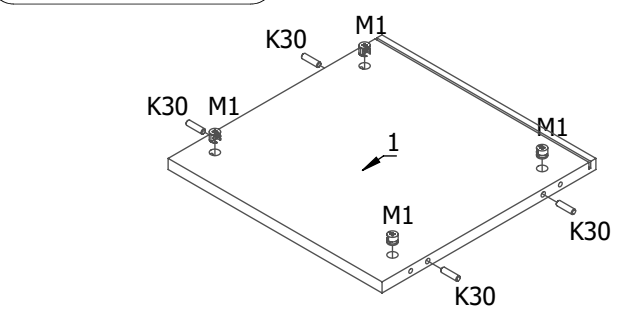



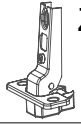

PZ 	M1 	K30 
2	8	8

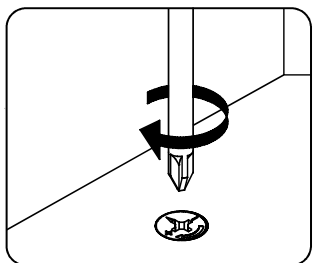
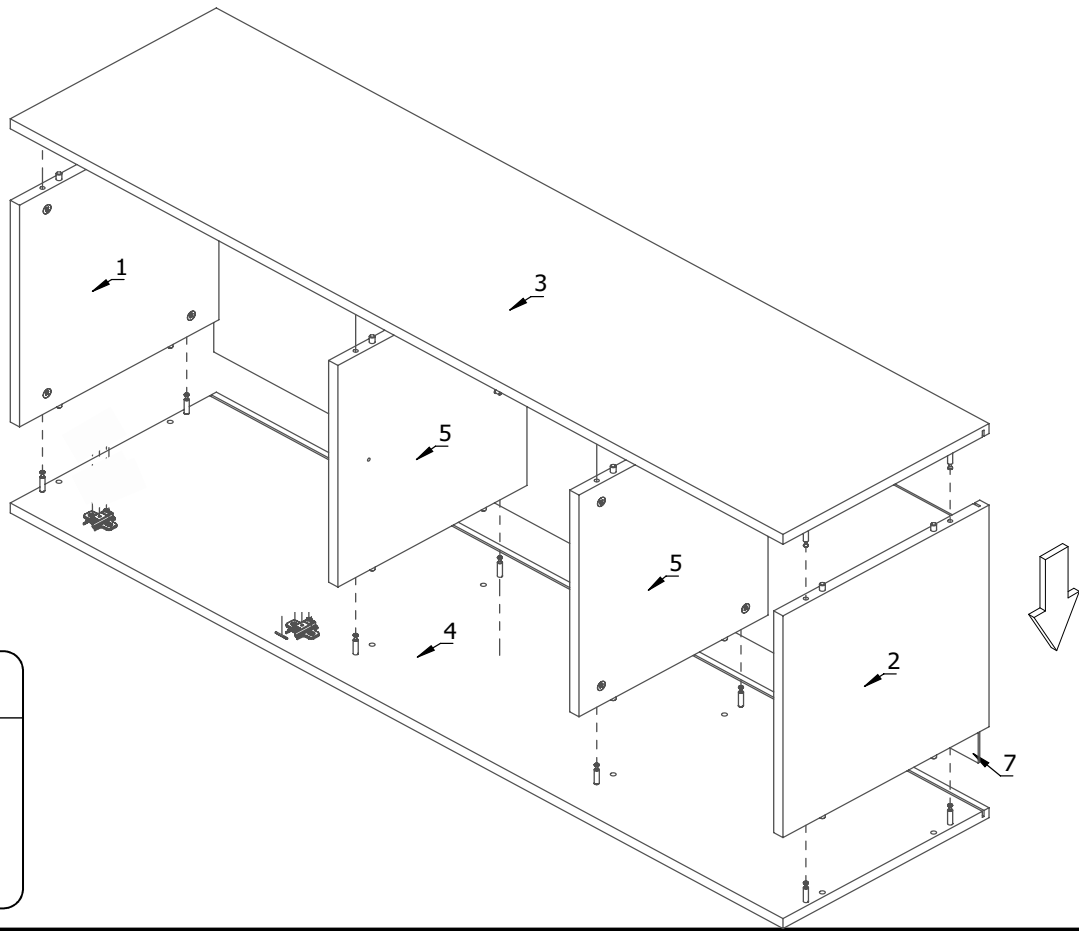
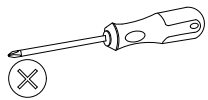
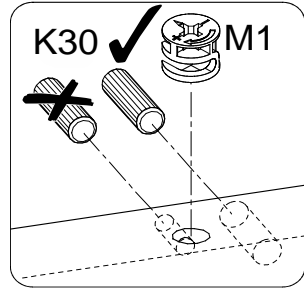
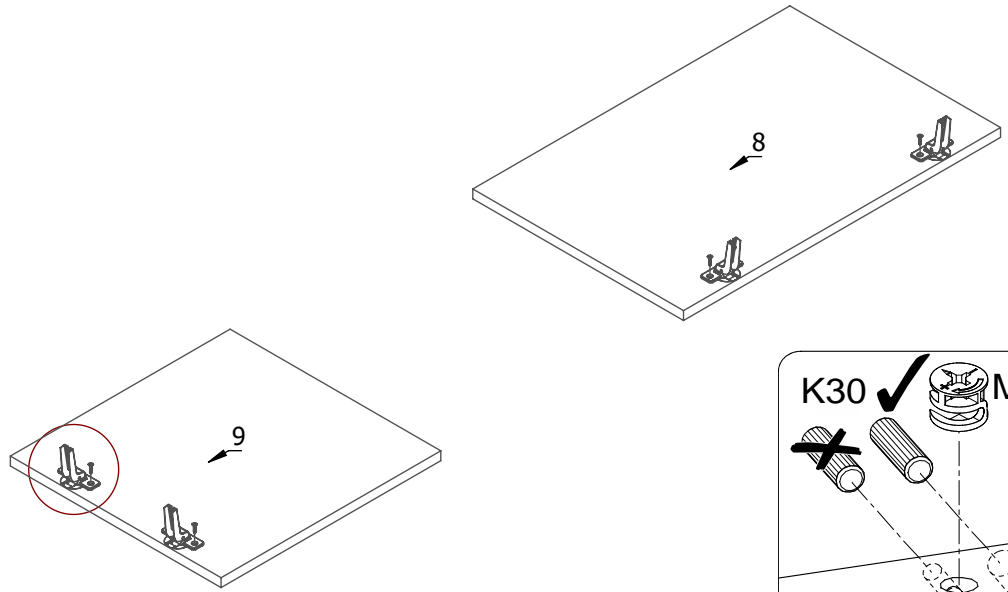
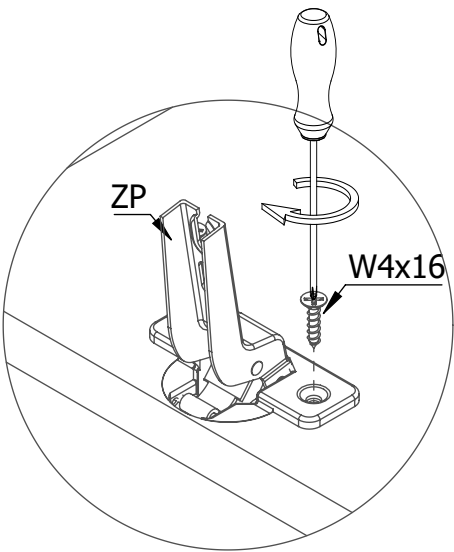
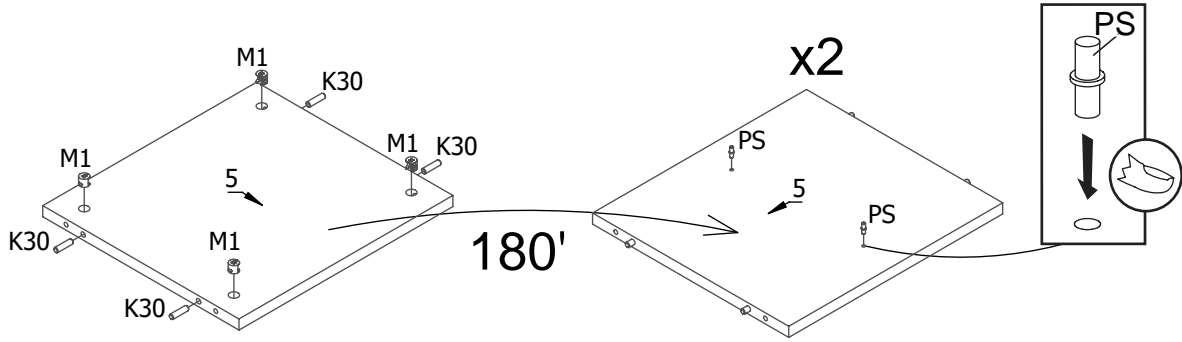

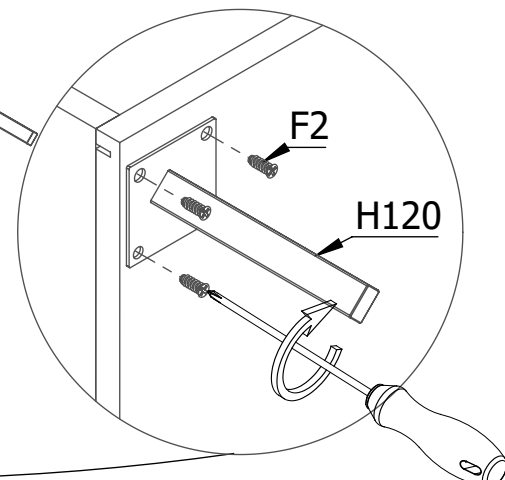
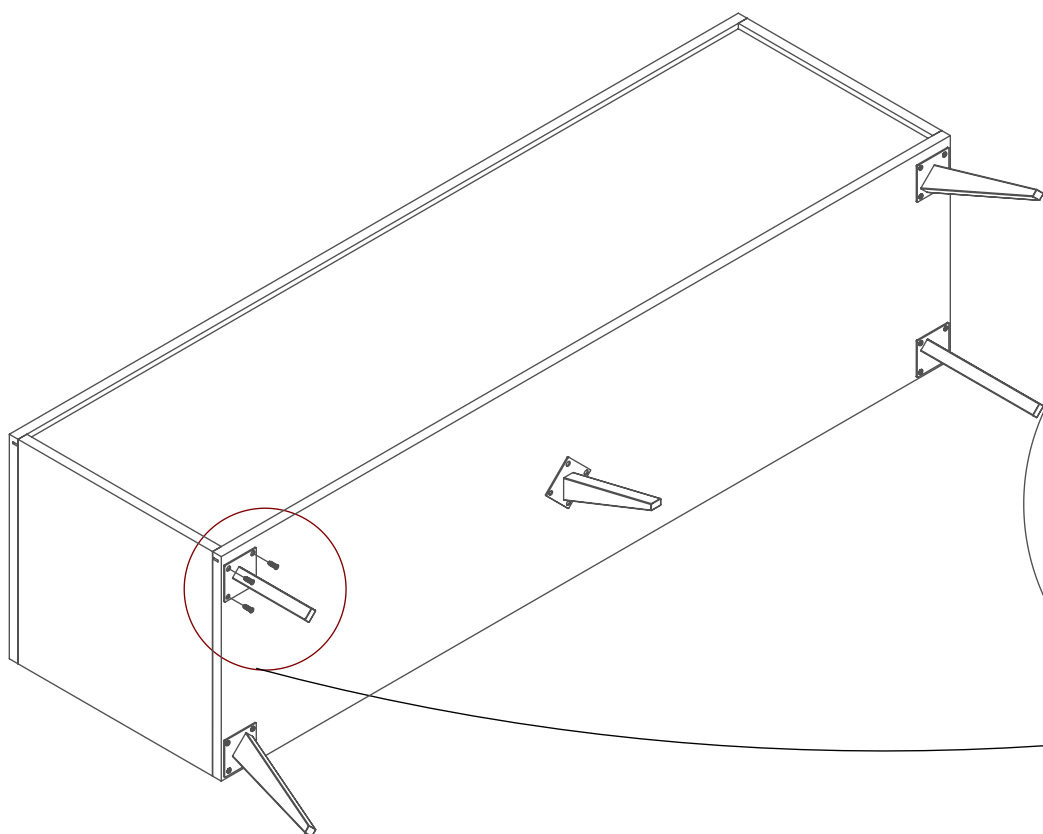
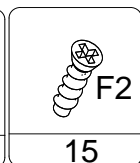
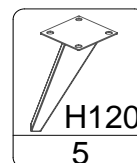
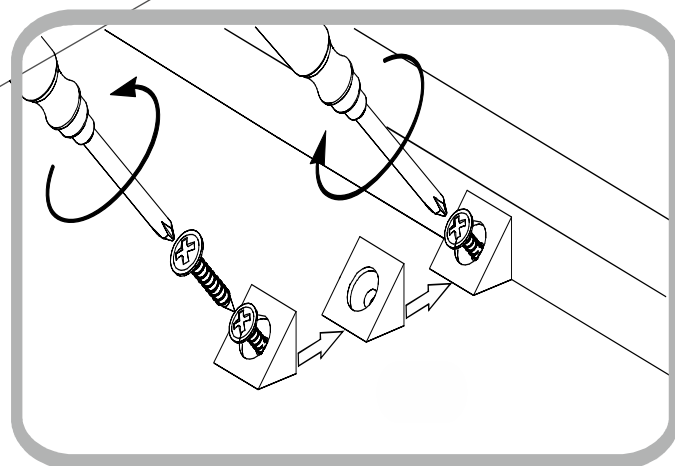
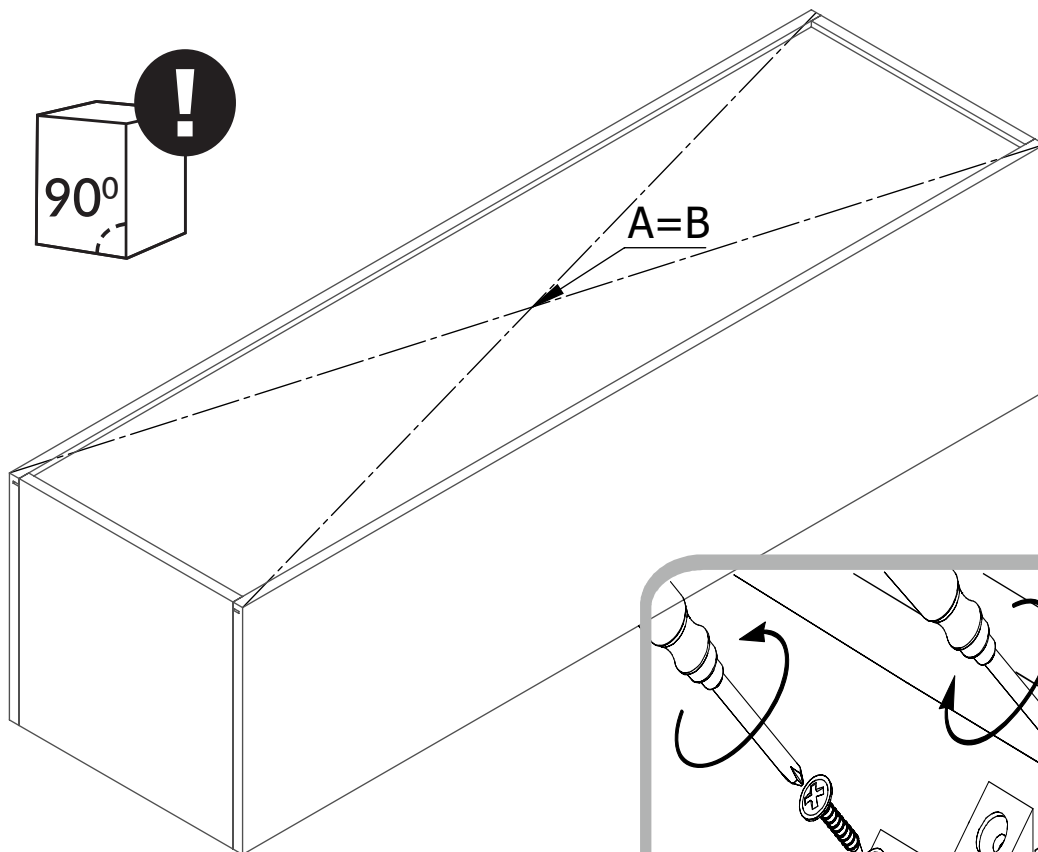
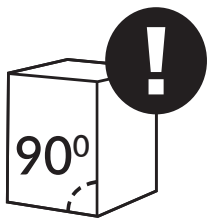
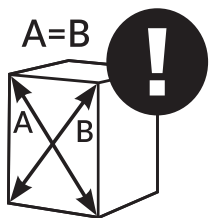
K30  8	W4x16  8	M1  8	PS  4	ZP  4
--	--	---	---	---





S1	S2	S3
		
1	1	1

